

FLAT PITCH SKYLIGHT WITH TURRET BASE

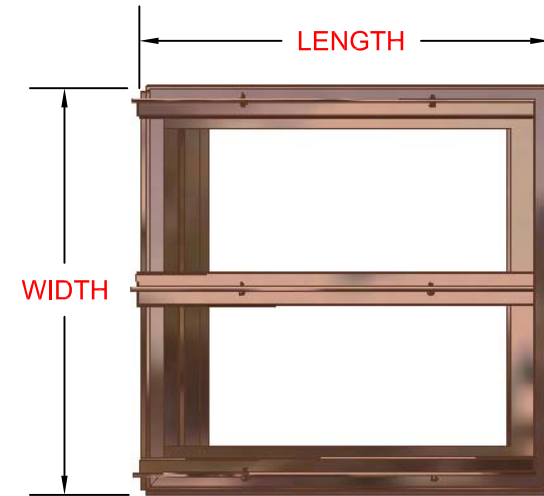
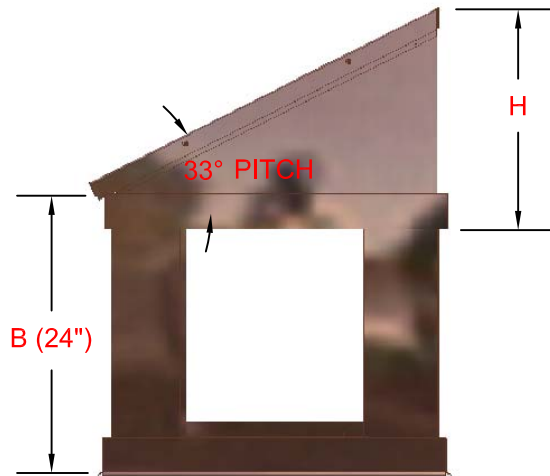
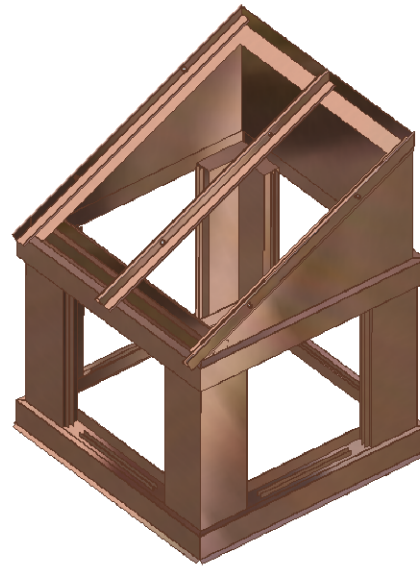

25-40 50 TH AVE.
 LIC, NY 11101
 P 718 433 2501
 F 718 433 2709
 info@bbsheetmetal.com
 www.bbsheetmetal.com

COMPANY:		DATE:
INVOICE:	PO#:	DRAWING #: SFR-03
PROJECT:		PAGE(S): 1 OF 2
INSTALLATION INSTRUCTION:		DRAWING BY: NELSON SUT HO
OTHER:		APPROVED BY: BOBBY BASCHNAGEL

FLAT PITCH SKYLIGHT WITH TURRET BASE

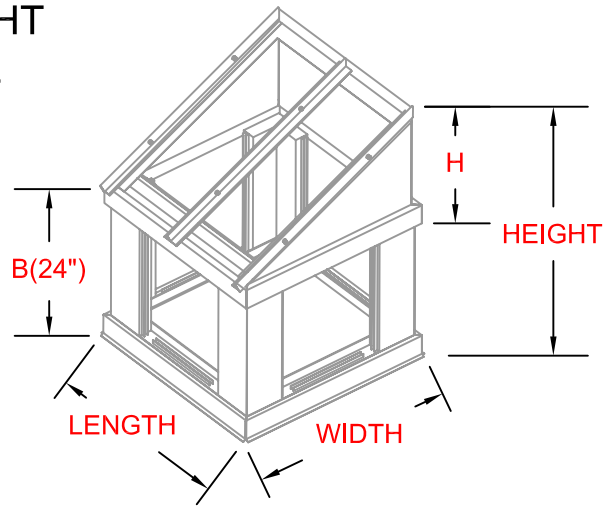

MATERIAL:

- | | | |
|---|-----------------------------|-----------------------------|
| <input type="checkbox"/> COPPER | <input type="checkbox"/> 16 | <input type="checkbox"/> 20 |
| <input type="checkbox"/> FREEDOM GRAY | <input type="checkbox"/> 16 | <input type="checkbox"/> 20 |
| <input type="checkbox"/> LEAD COATED COPPER | <input type="checkbox"/> 16 | <input type="checkbox"/> 20 |
| <input type="checkbox"/> EVERGREEN COPPER | <input type="checkbox"/> 16 | <input type="checkbox"/> 20 |
| <input type="checkbox"/> GALVANIZED | <input type="checkbox"/> 24 | <input type="checkbox"/> 26 |
| <input type="checkbox"/> TERNE COATED STAINLESS STEEL | <input type="checkbox"/> 26 | |

GLASS TYPE:

- NO GLASS
- 1" BRONZE INSULATED UNIT
- 1" LOW E INSULATED UNIT
- 1" WHITE LAMINATED SAFETY
- 1/4" DIAMOND CLEAR WIRE
- 1/4" SQUARE HAMMER WIRE
- 1/4" LAMINATED SAFETY
- 1/4" WHITE LAMINATED SAFETY
- 1/4" RIBBED

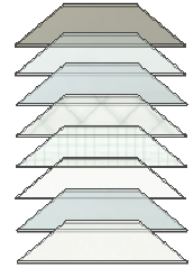

PROTECTIVE SCREEN:

- NO PROTECTIVE SCREEN
- TOP
- BOTTOM
- TOP & BOTTOM

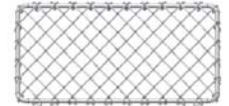

WIDTH: [] LENGTH: [] HEIGHT: B: [] STANDARD 24"
 H: **CUSTOM** []

OFFICE USE ONLY

BARS:

COMMON BAR

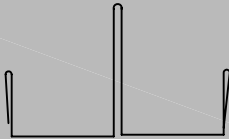

PUDDY BAR

SMALL



LARGE

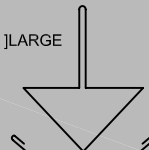

ONCE THE FABRICATION BEGINS, ITEMS CANNOT BE RETURNED. THE DETAILS FOR THIS JOB WERE CHECKED AND APPROVED BY:

B & B SALES REP

NAME: _____ SIGN: X _____

DATE: __ / __ / __



25-40 50 TH AVE.
 LIC, NY 11101
 P 718 433 2501
 F 718 433 2709
 info@bbsheetmetal.com
 www.bbsheetmetal.com

COMPANY:	DATE:
INVOICE: PO#:	DRAWING #: SFR-03
PROJECT:	PAGE(S): 2 OF 2
INSTALLATION INSTRUCTION:	DRAWING BY: NELSON SUT HO
OTHER:	APPROVED BY: BOBBY BASCHNAGEL